

Combo No.1

SKU: FDCU_13-23_L1H1_C1

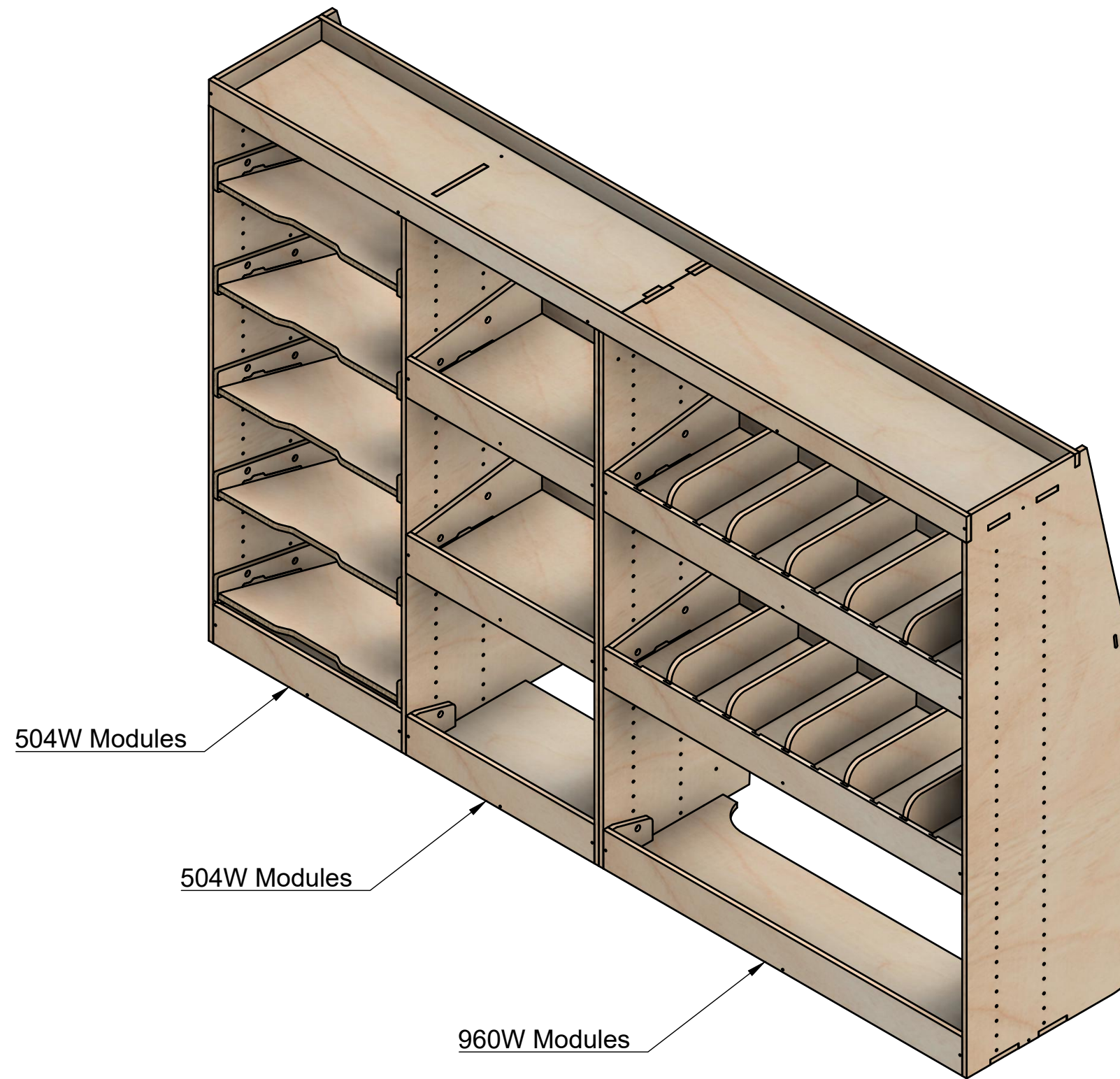

Page 1 - Overview

All units in mm

Plywood thickness = 12mm

Notes

- The spacing of internal modules can be adjusted up or down.
- Each section of rack can accept other modules with the same width.
- All dividers are removable.

YOKE VANS

info@yoke-van-kits.co.uk

0208 132 9221

© 2023 Yoke CNC LTD

Combo No.1

SKU: FDCU_13-23_L1H1_C1

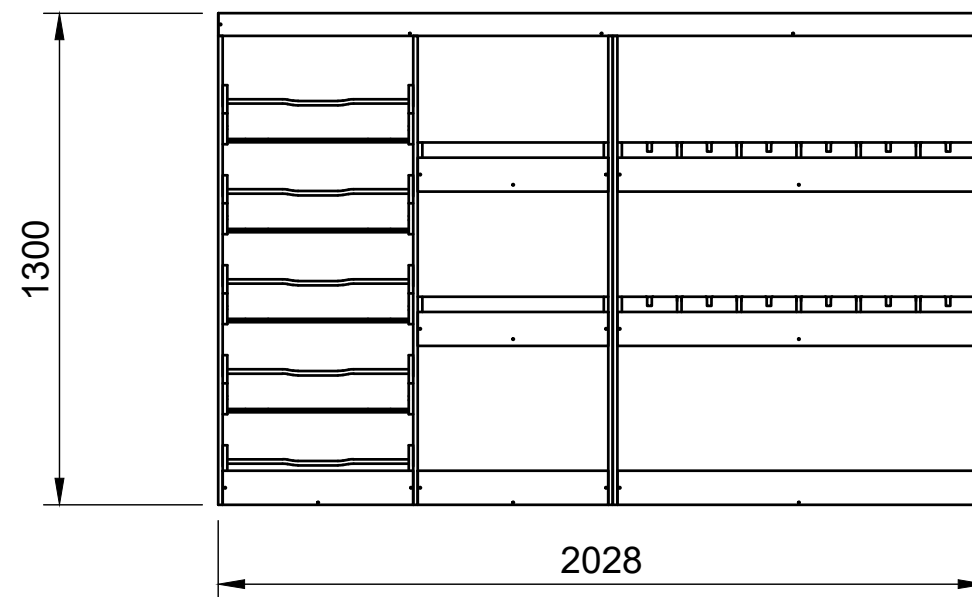
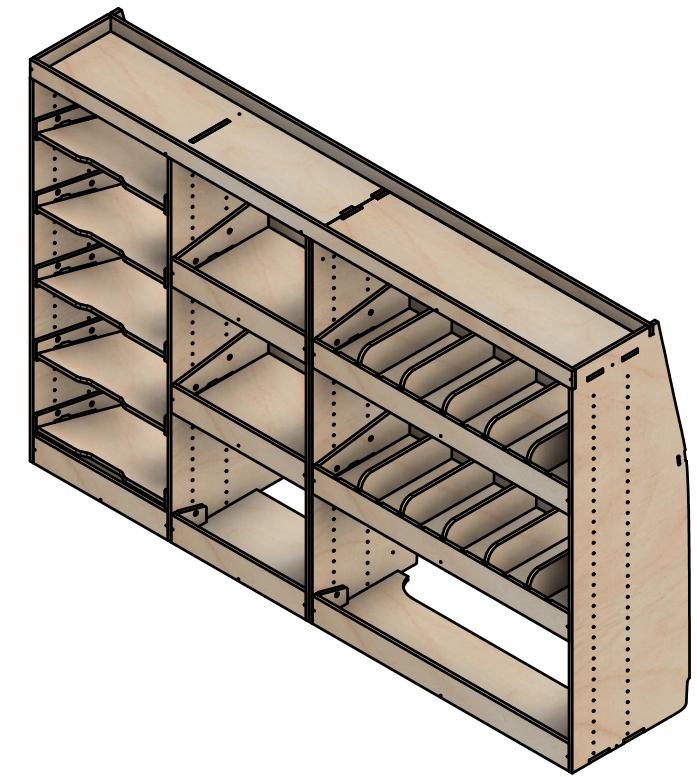
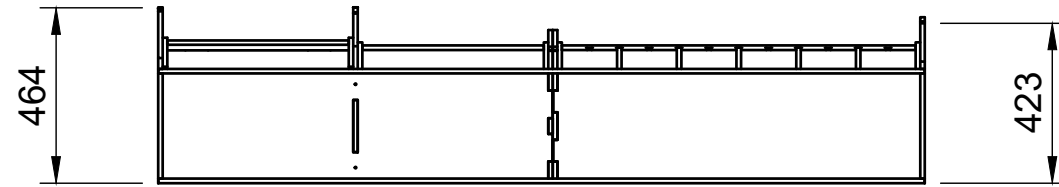

Page 2 - External Dimensions

All units in mm

Plywood thickness = 12mm

Notes

- All dimensions on this page are external.

YOKE VANS
info@yoke-van-kits.co.uk
0208 132 9221

© 2023 Yoke CNC LTD

Combo No.1

SKU: FDCU_13-23_L1H1_C1

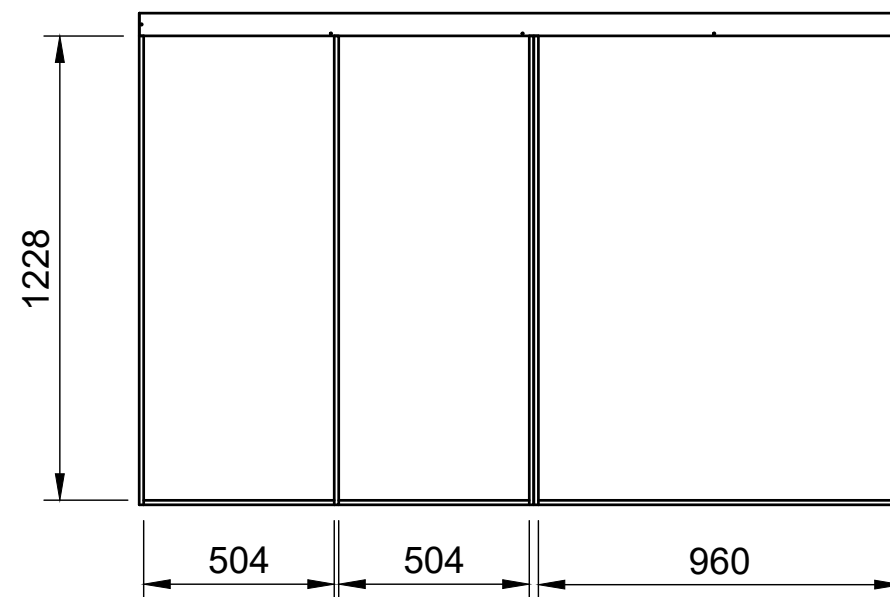
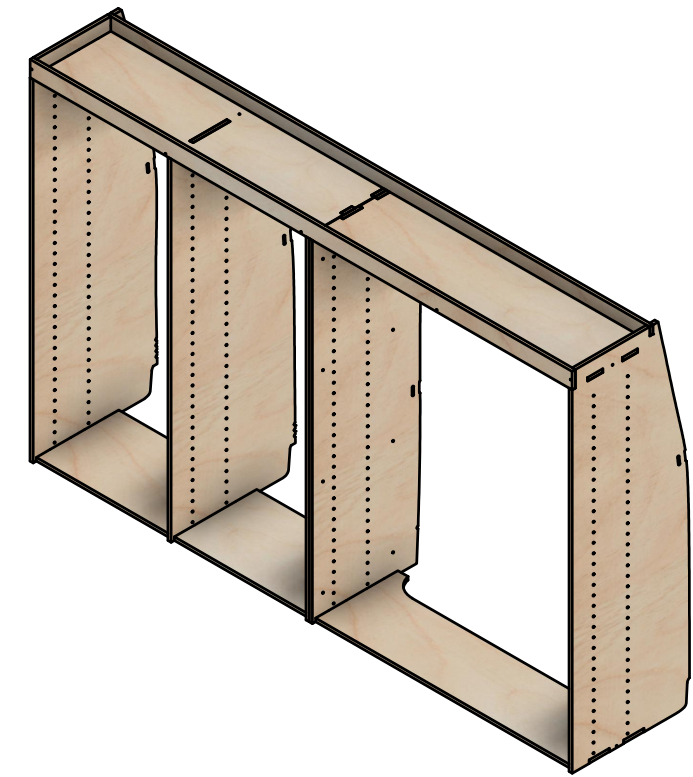
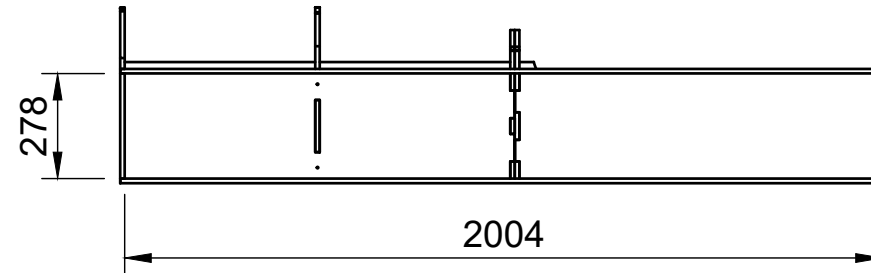

Page 3 - Internal Dimensions

All units in mm

Plywood thickness = 12mm

Notes

- All Dimensions on this page are internal.
- Each section of rack can accept other modules with the same width.

YOKE VANS
info@yoke-van-kits.co.uk
0208 132 9221

© 2023 Yoke CNC LTD