

Renault Trafic | 2014on | L1H1 (SWB) | Panel Van
Vauxhall Vivaro | 2014-19 | L1H1 (SWB) | Panel Van
Nissan NV300 | 2016on | L1H1 (SWB) | Panel Van
Fiat Talento | 2016-20 | L1H1 (SWB) | Panel Van

Combo No.7

SKU: TVN_14_L1_C7

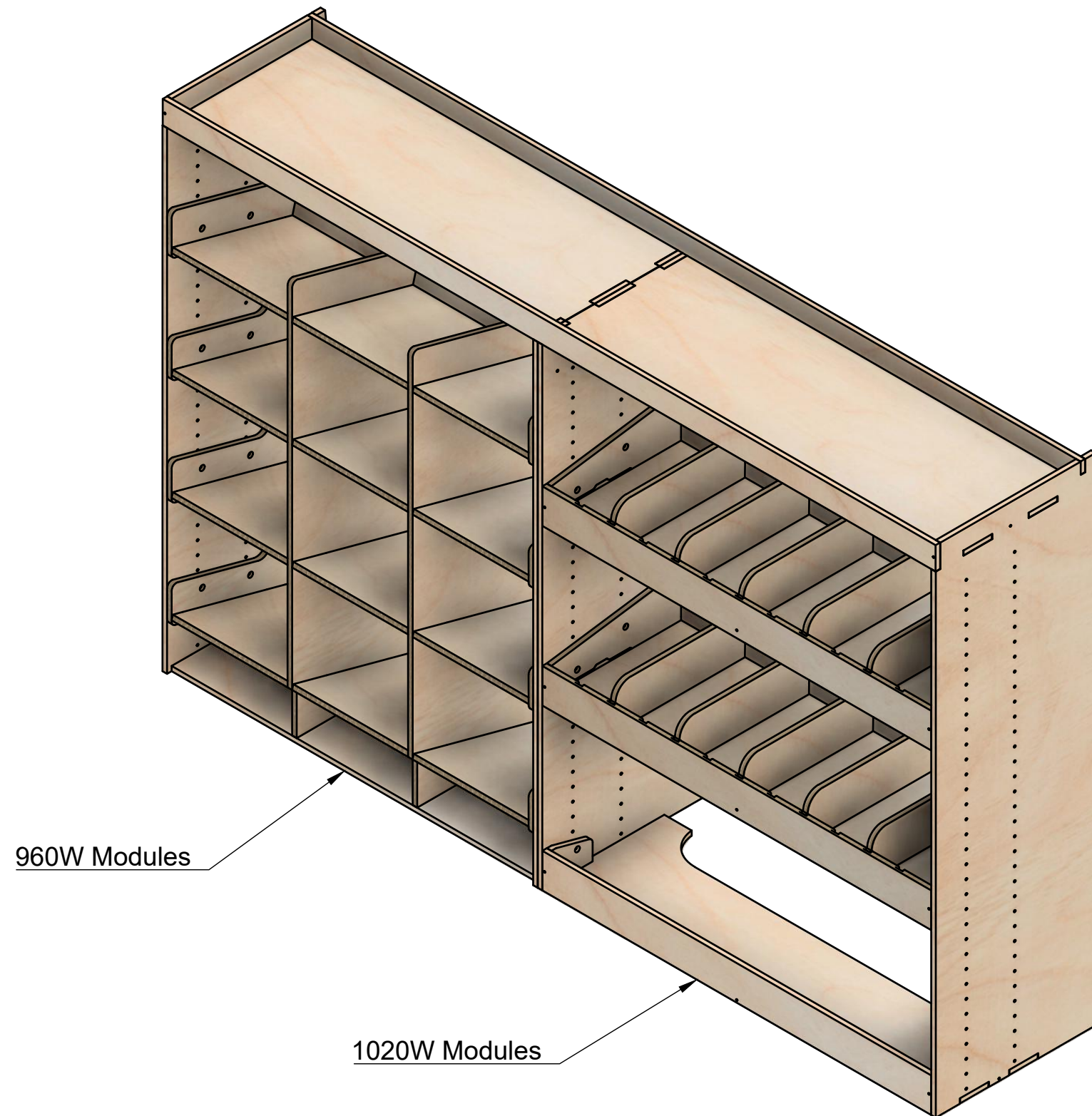

Page 1 - Overview

All units in mm

Plywood thickness = 12mm

Notes

- The spacing of most internal modules can be adjusted up or down.
- Each section of rack can accept other modules with the same width.
- The 960W euro crate module is constructed as 1 interlocked module. The shelf spacing of that module is fixed.

YOKE VANS

info@yoke-van-kits.co.uk

0208 132 9221

© 2023 Yoke CNC LTD

Renault Trafic | 2014on | L1H1 (SWB) | Panel Van
Vauxhall Vivaro | 2014-19 | L1H1 (SWB) | Panel Van
Nissan NV300 | 2016on | L1H1 (SWB) | Panel Van
Fiat Talento | 2016-20 | L1H1 (SWB) | Panel Van

Combo No.7

SKU: TVN_14_L1_C7

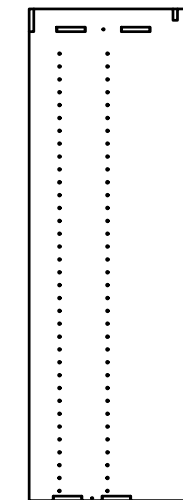
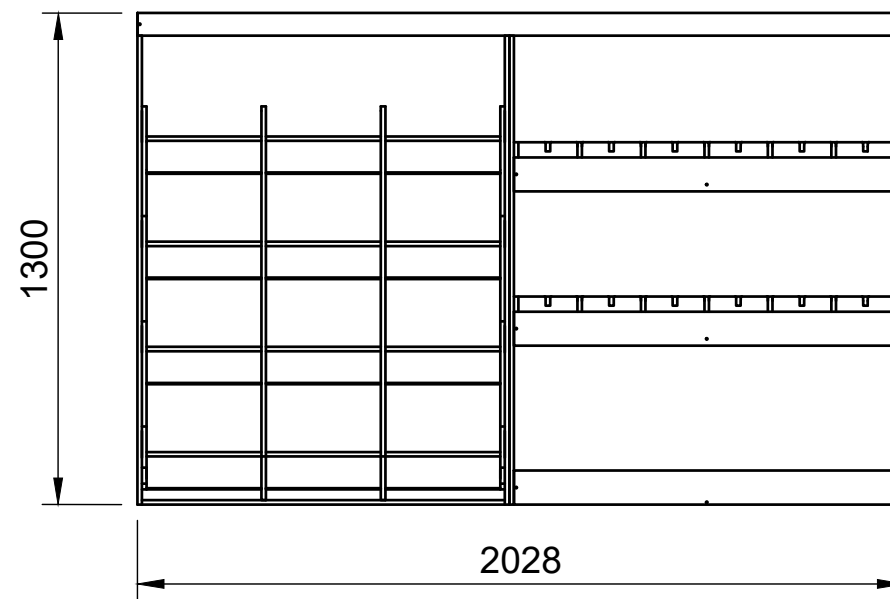
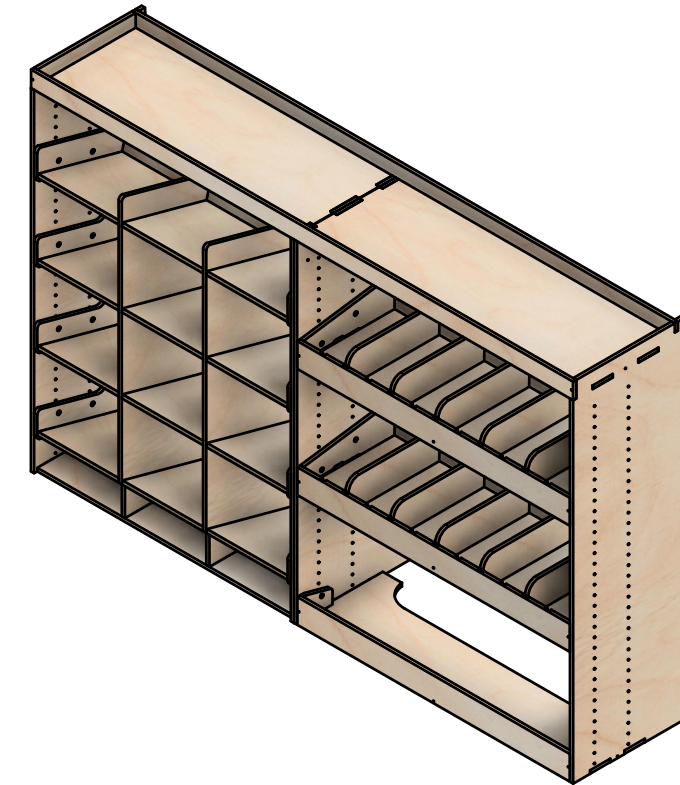
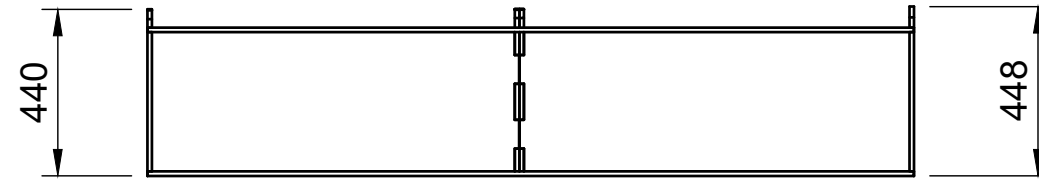

Page 2 - External Dimensions

All units in mm

Plywood thickness = 12mm

Notes

- All dimensions on this page are external.

YOKE VANS
info@yoke-van-kits.co.uk
0208 132 9221

© 2023 Yoke CNC LTD

Renault Trafic | 2014on | L1H1 (SWB) | Panel Van
Vauxhall Vivaro | 2014-19 | L1H1 (SWB) | Panel Van
Nissan NV300 | 2016on | L1H1 (SWB) | Panel Van
Fiat Talento | 2016-20 | L1H1 (SWB) | Panel Van

Combo No.7

SKU: TVN_14_L1_C7

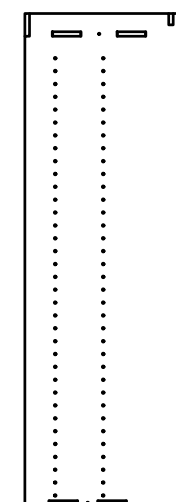
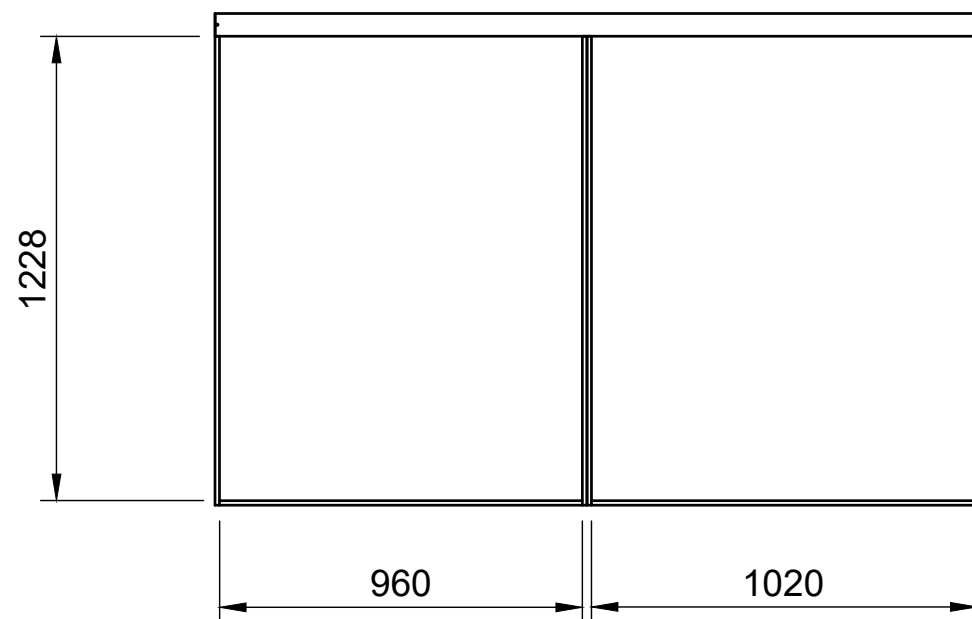
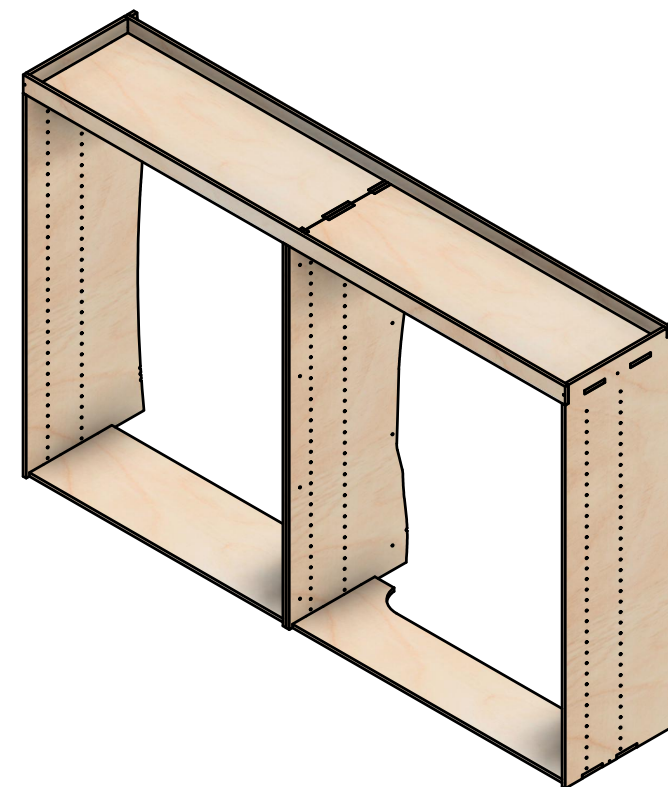
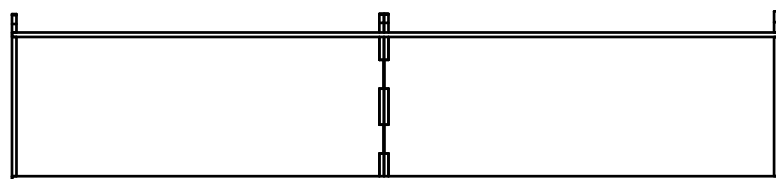

Page 3 - Internal Dimensions

All units in mm

Plywood thickness = 12mm

Notes

- All Dimensions on this page are internal.
- Each section of rack can accept other modules with the same width.

YOKE VANS
info@yoke-van-kits.co.uk
0208 132 9221

© 2023 Yoke CNC LTD