

Combo No.6

SKU: FCON_14_L1_C2

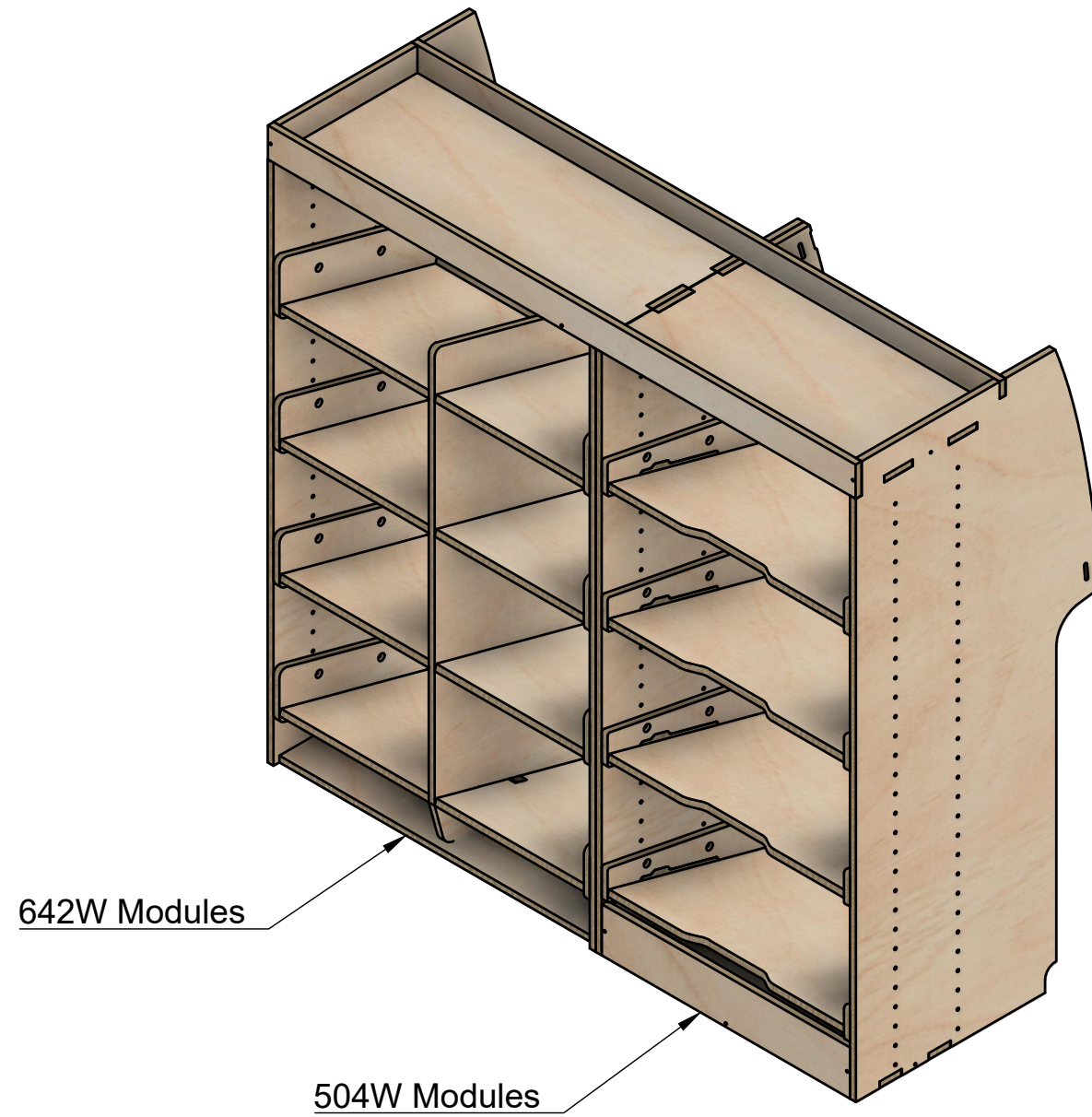

Page 1 - Overview

All units in mm

Plywood thickness = 12mm

YOKE VANS
info@yoke-van-kits.co.uk
0208 132 9221

© 2023 Yoke CNC LTD

Combo No.6

SKU: FCON_14_L1_C2

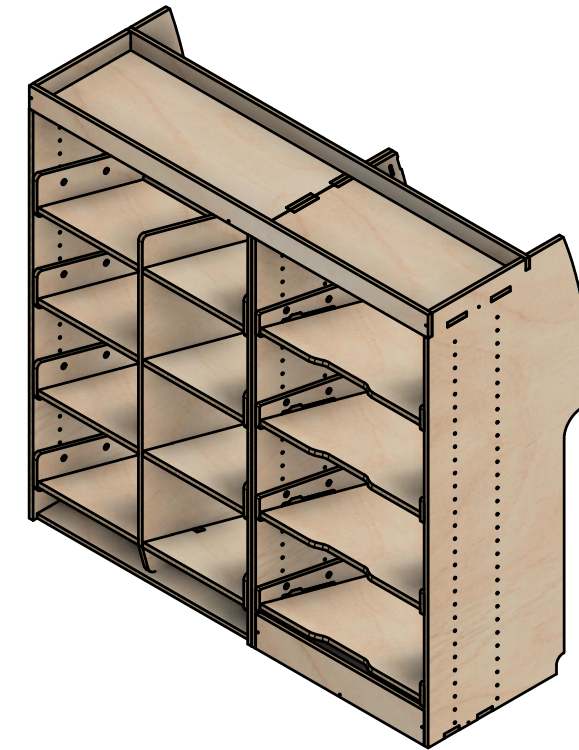
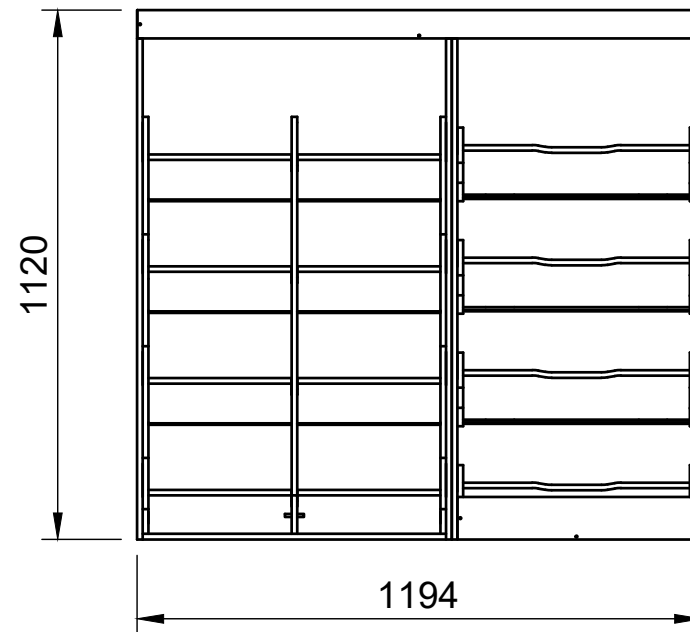
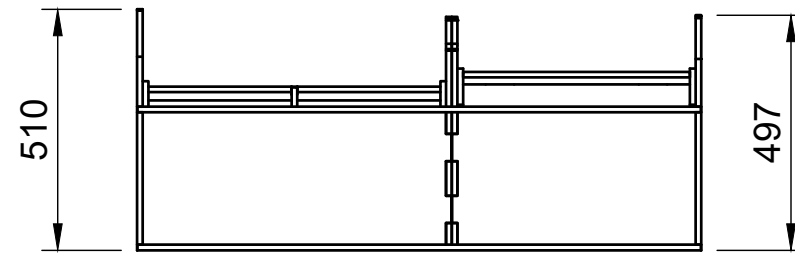

Page 2 - External Dimensions

All units in mm

Plywood thickness = 12mm

Notes

- All dimensions on this page are external.

YOKE VANS
info@yoke-van-kits.co.uk
0208 132 9221

© 2023 Yoke CNC LTD

Combo No.6

SKU: FCON_14_L1_C2

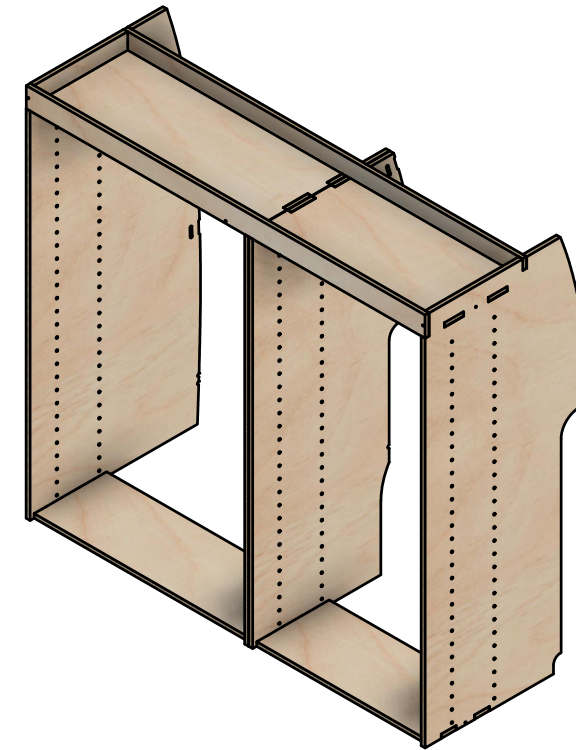
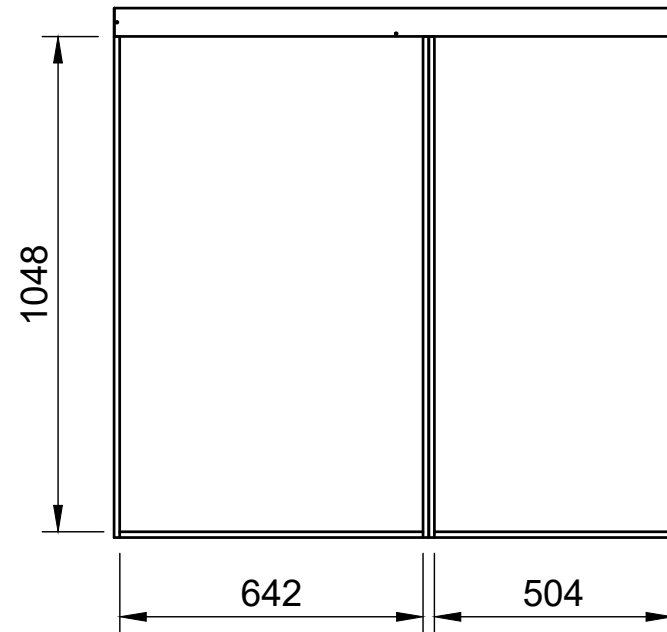
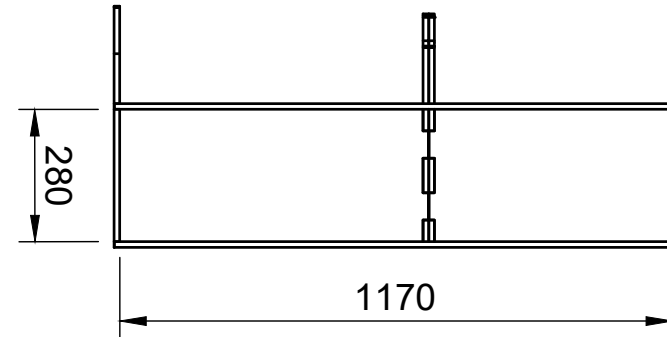

Page 3 - Internal Dimensions

All units in mm

Plywood thickness = 12mm

Notes

- All dimensions on this page are internal.

YOKE VANS
info@yoke-van-kits.co.uk
0208 132 9221

© 2023 Yoke CNC LTD