

Combo No.17

SKU: FDCU_13-23_L1H1_C17

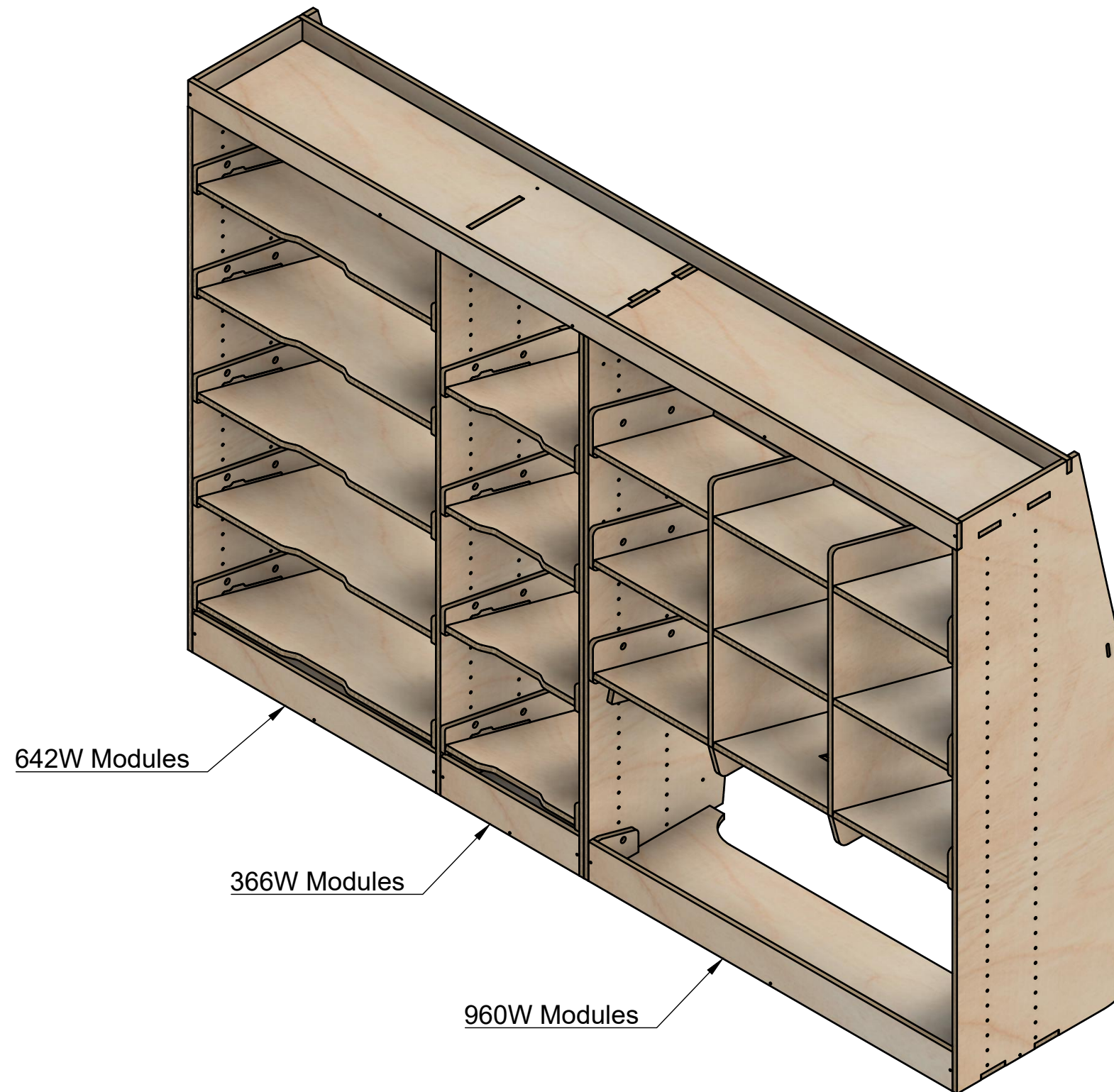

Page 1 - Overview

All units in mm

Plywood thickness = 12mm

Notes

- The spacing of most internal modules can be adjusted up or down.
- Each section of rack can accept other modules with the same width.
- The 960W euro crate module is constructed as 1 interlocked module. The shelf spacing of that module is fixed.

YOKE VANS

info@yoke-van-kits.co.uk

0208 132 9221

© 2023 Yoke CNC LTD

Combo No.17

SKU: FDCU_13-23_L1H1_C17

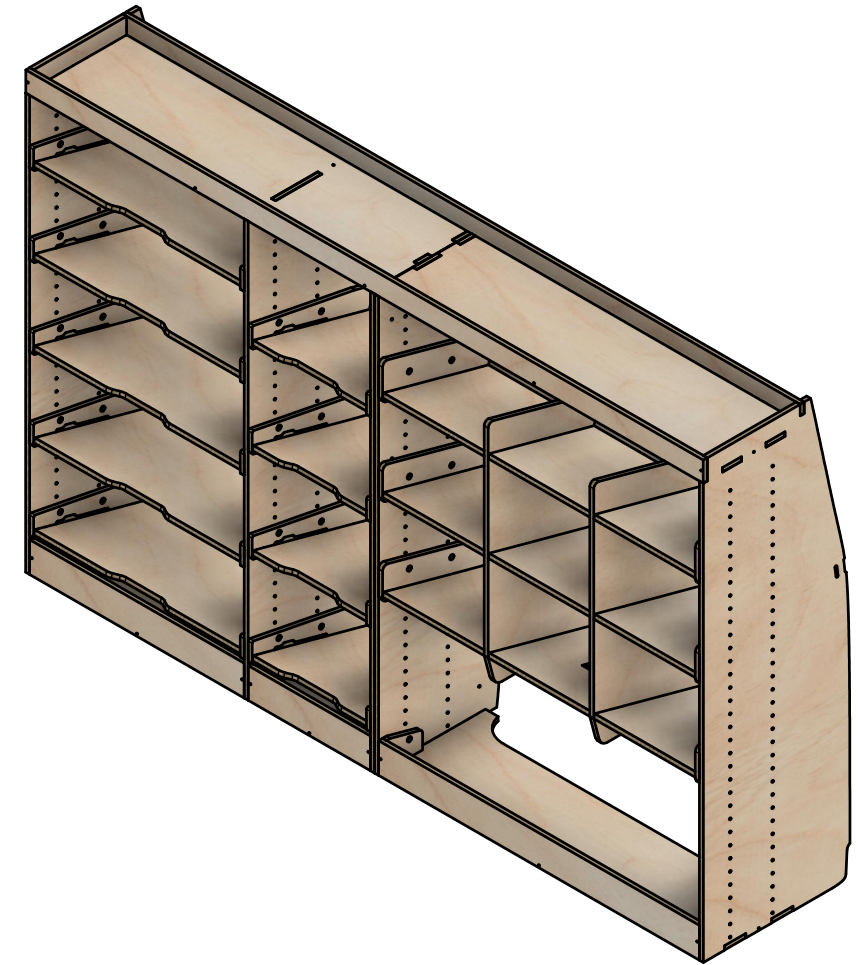
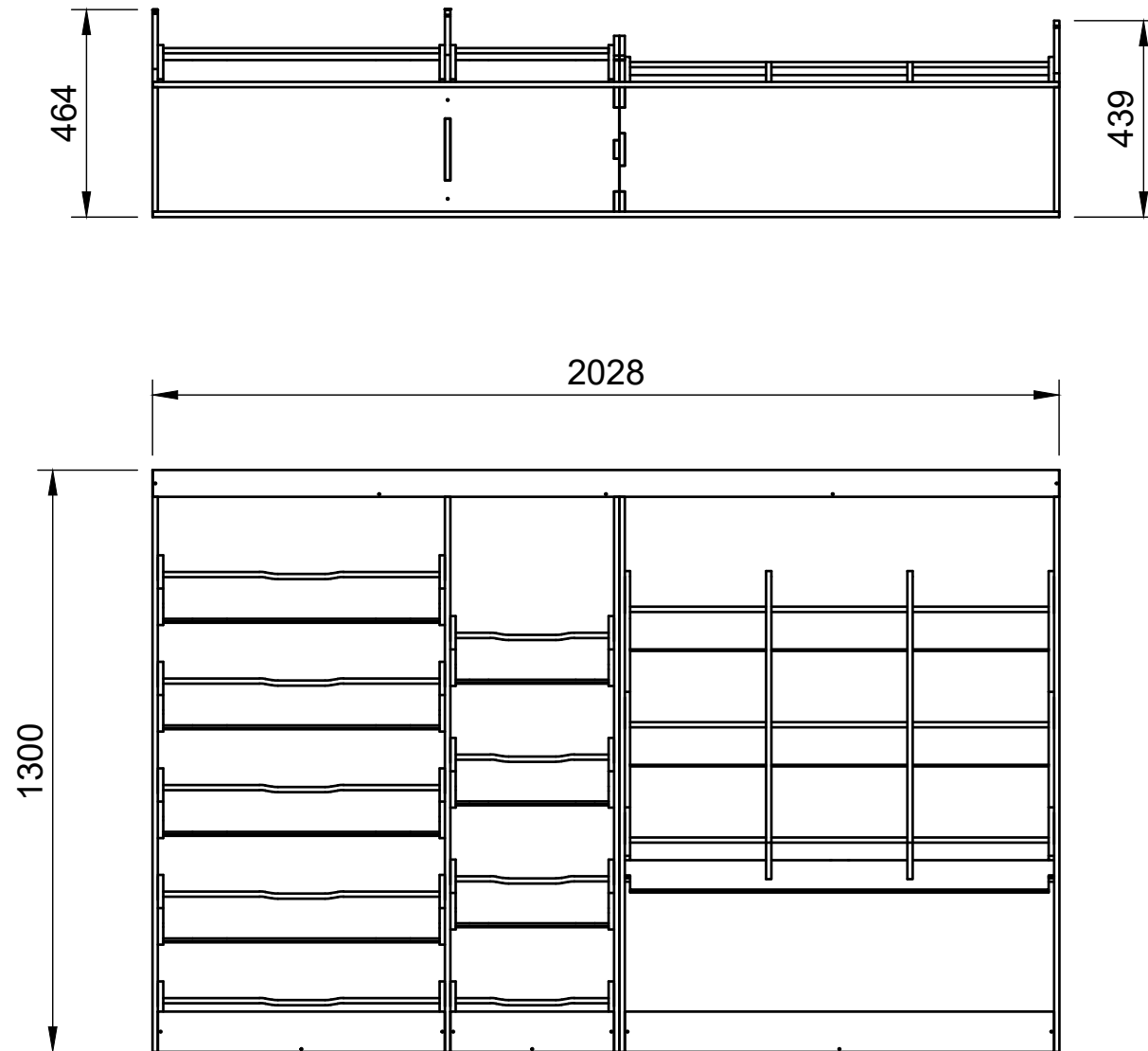

Page 2 - External Dimensions

All units in mm

Plywood thickness = 12mm

Notes

- All dimensions on this page are external.

YOKE VANS

info@yoke-van-kits.co.uk

0208 132 9221

© 2023 Yoke CNC LTD

Combo No.17

SKU: FDCU_13-23_L1H1_C17

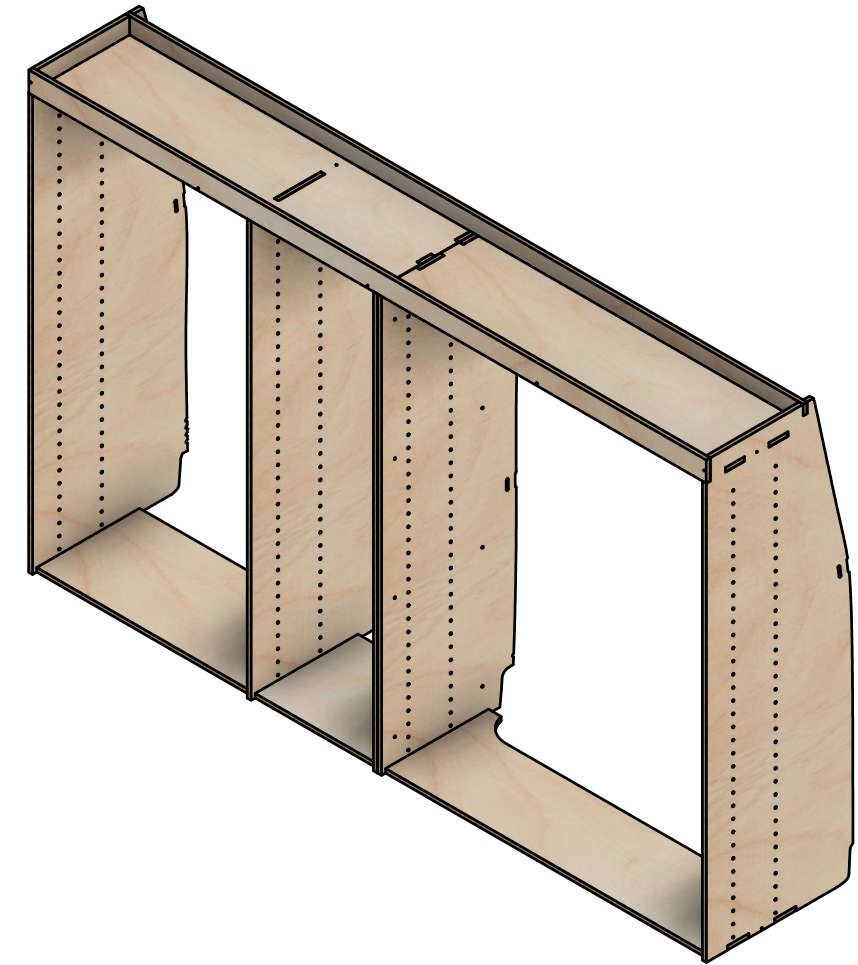
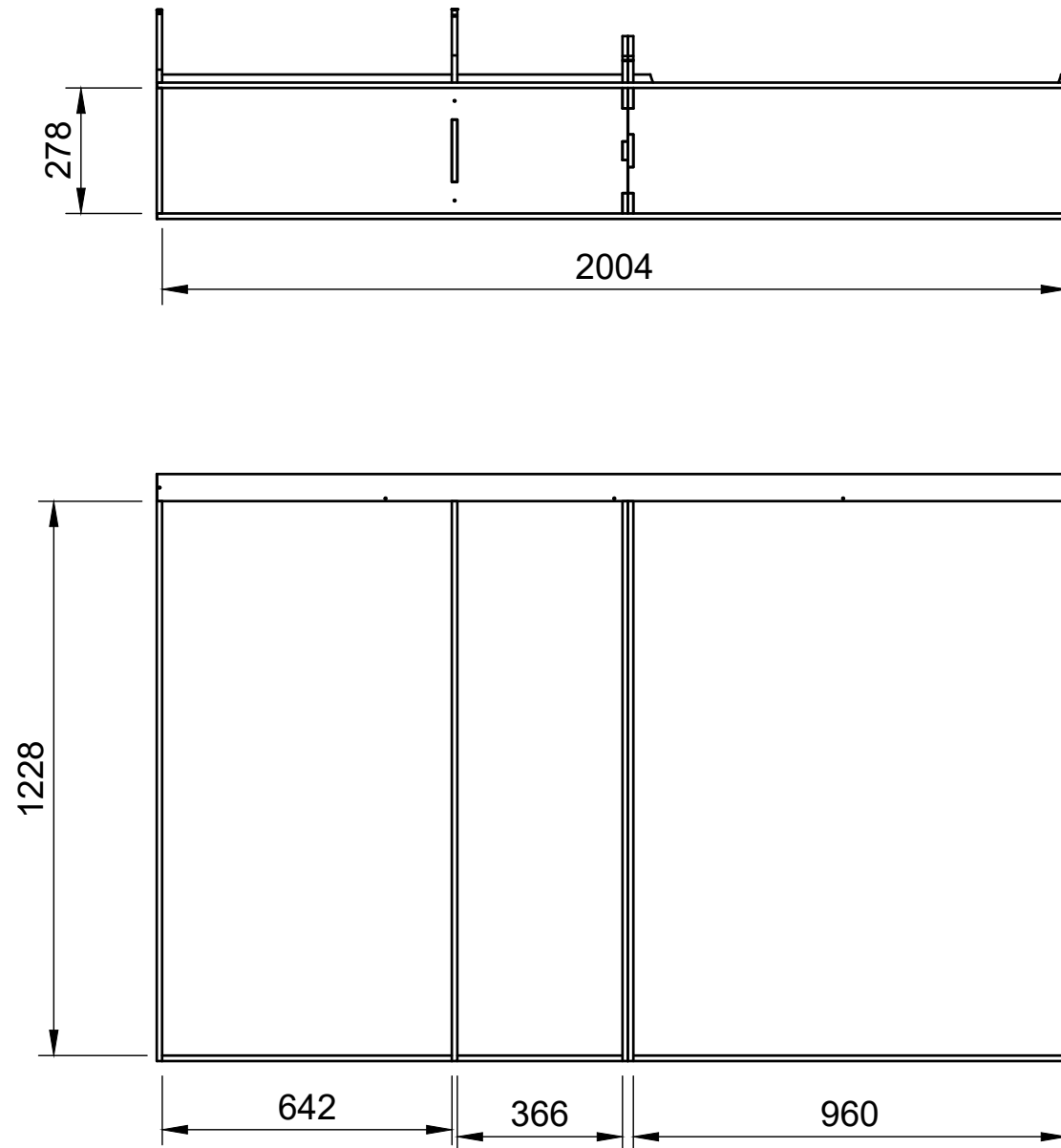

Page 3 - Internal Dimensions

All units in mm

Plywood thickness = 12mm

Notes

- All Dimensions on this page are internal.
- Each section of rack can accept other modules with the same width.

YOKE VANS
info@yoke-van-kits.co.uk
0208 132 9221

© 2023 Yoke CNC LTD