

# False Floor No.3B

SKU: BP\_18\_L1\_FF3B

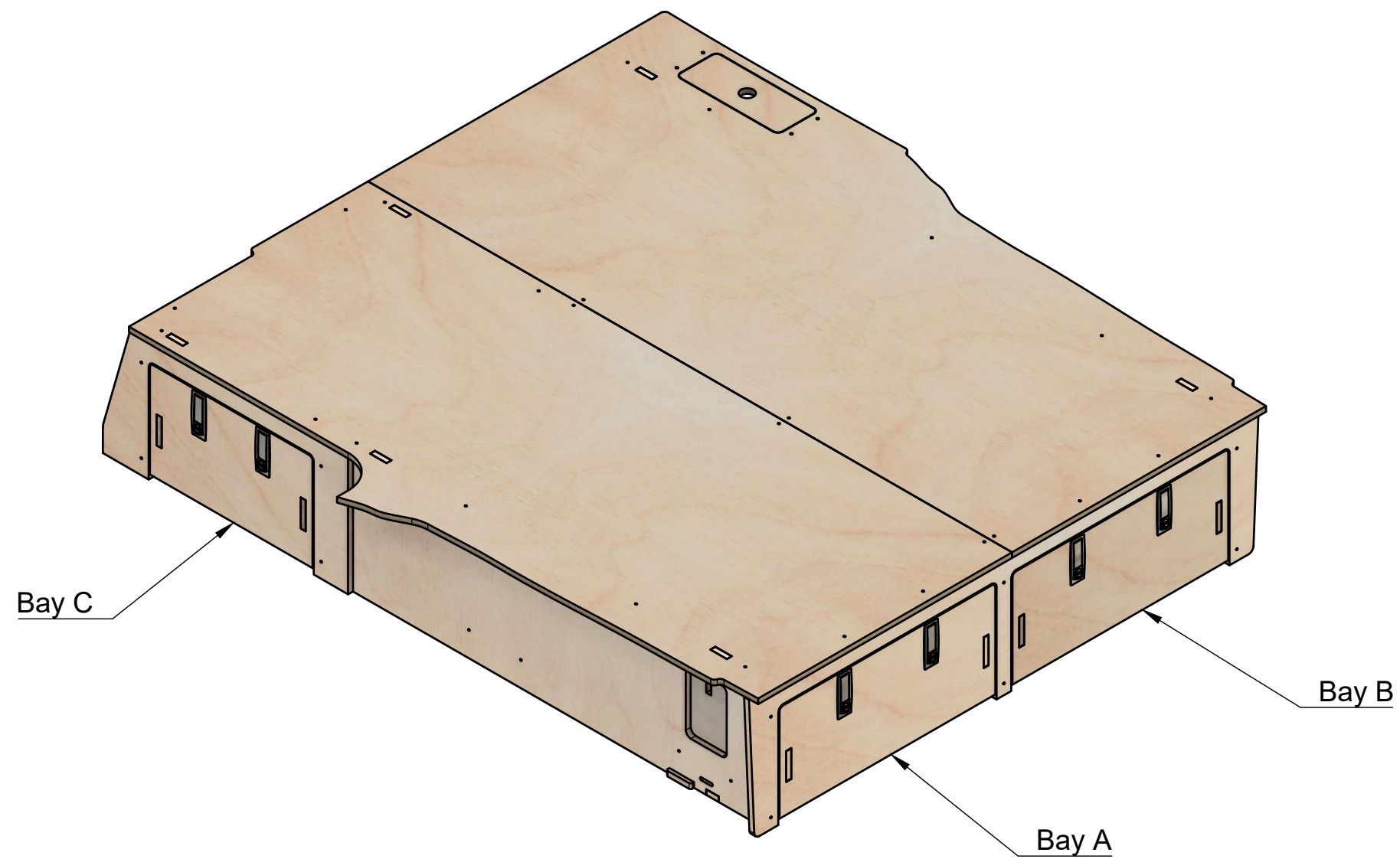

## Page 1 - Floor Only

All units in mm  
Plywood thickness = 12mm

**YOKE VANS**  
info@yoke-van-kits.co.uk  
0208 132 9221

© 2023 Yoke CNC LTD

# False Floor No.3B

SKU: BP\_18\_L1\_FF3B

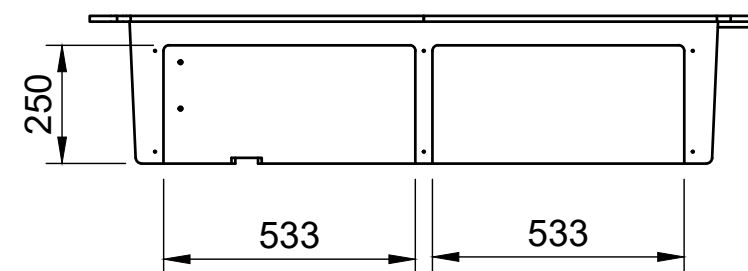
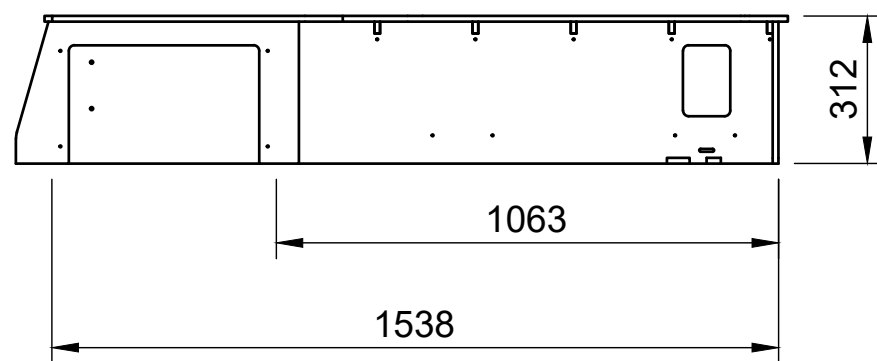
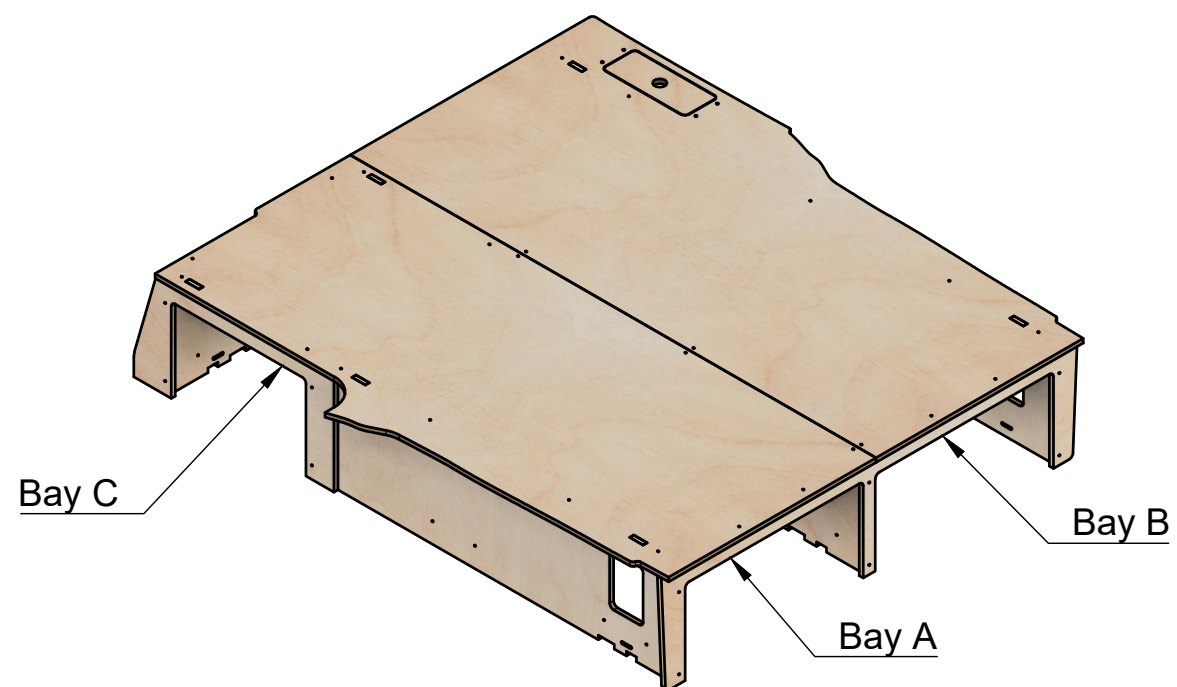

## Page 2 - Floor Dimensions

All units in mm  
Plywood thickness = 12mm

# False Floor No.3B

SKU: BP\_18\_L1\_FF3B

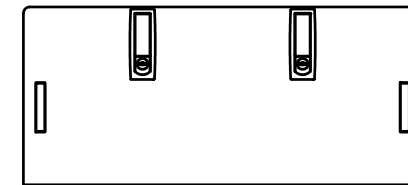
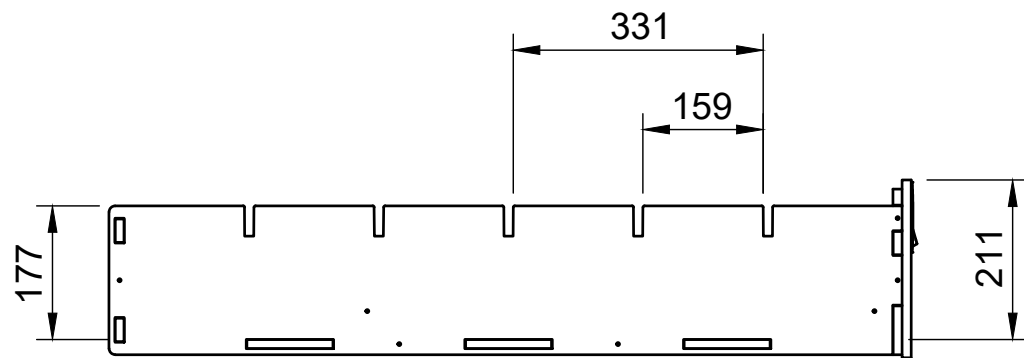
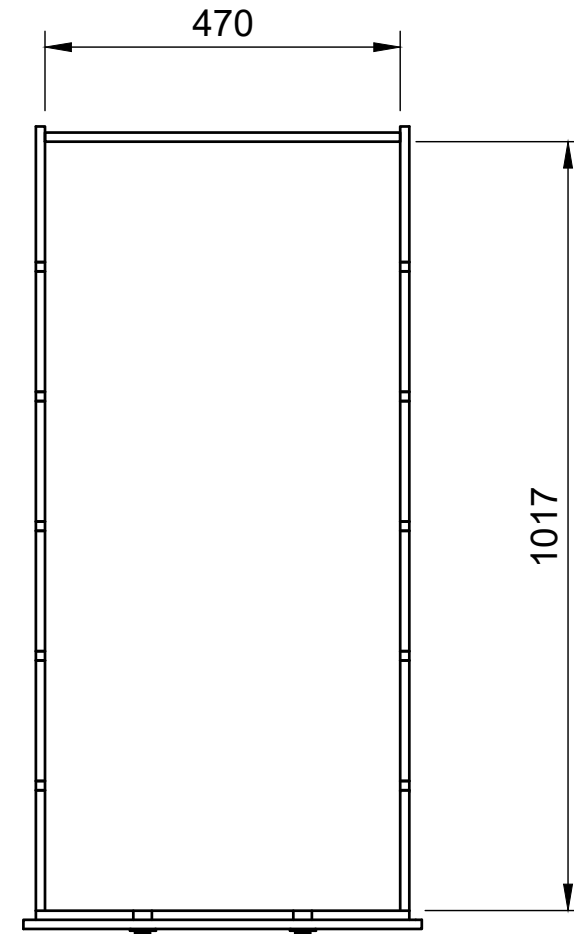
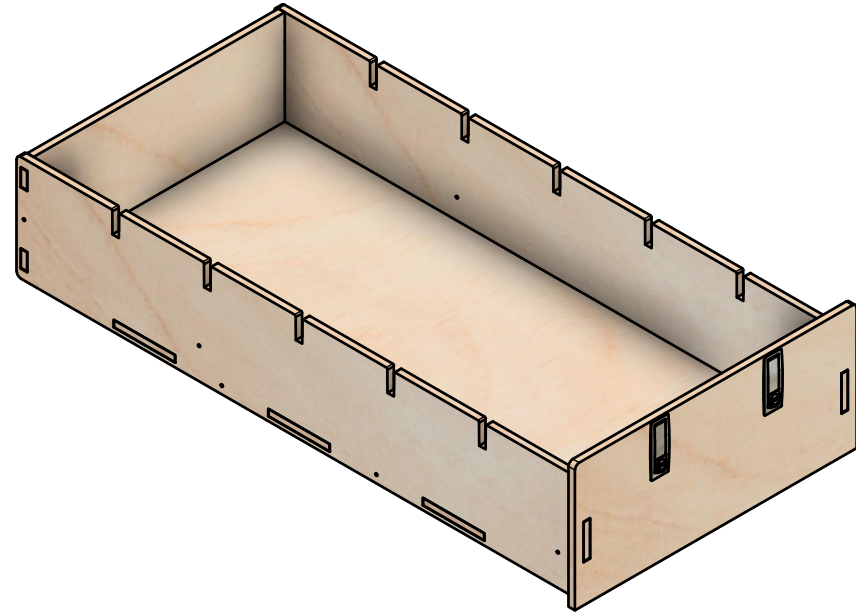

## Page 3 - Bay A Drawer Dimensions

All units in mm  
Plywood thickness = 12mm

# False Floor No.3B

SKU: BP\_18\_L1\_FF3B

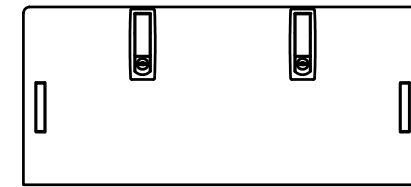
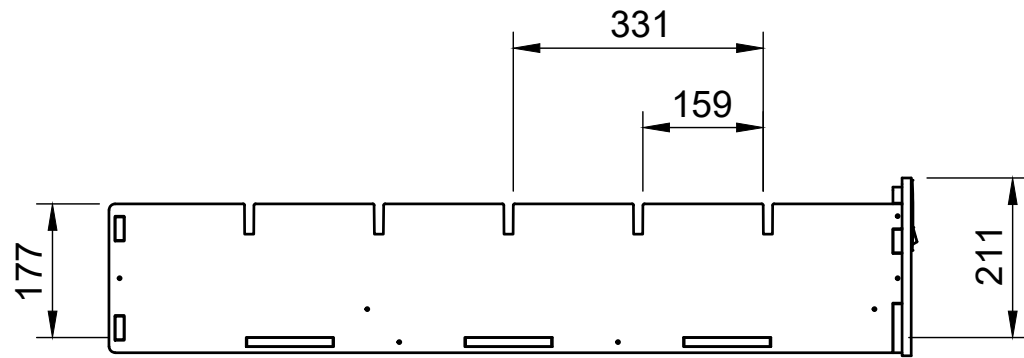
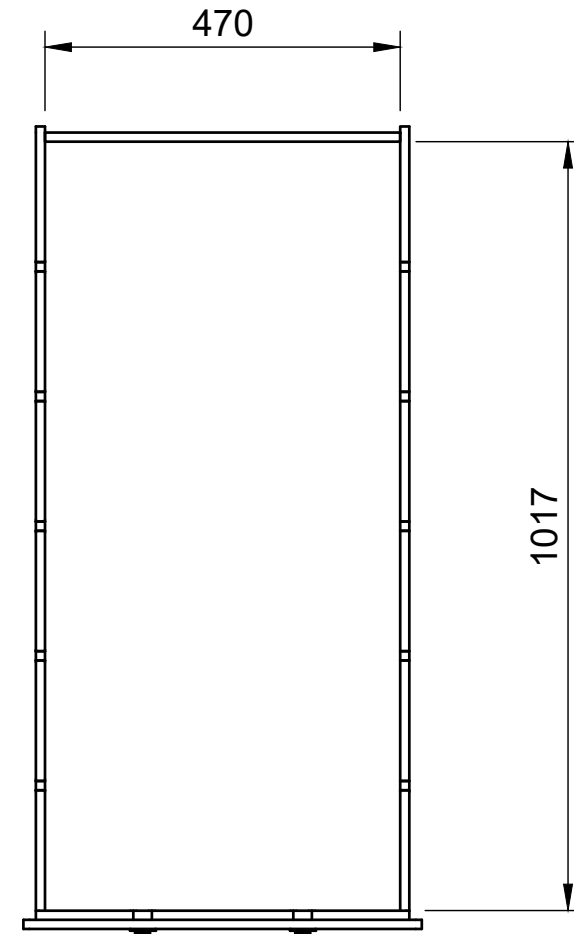
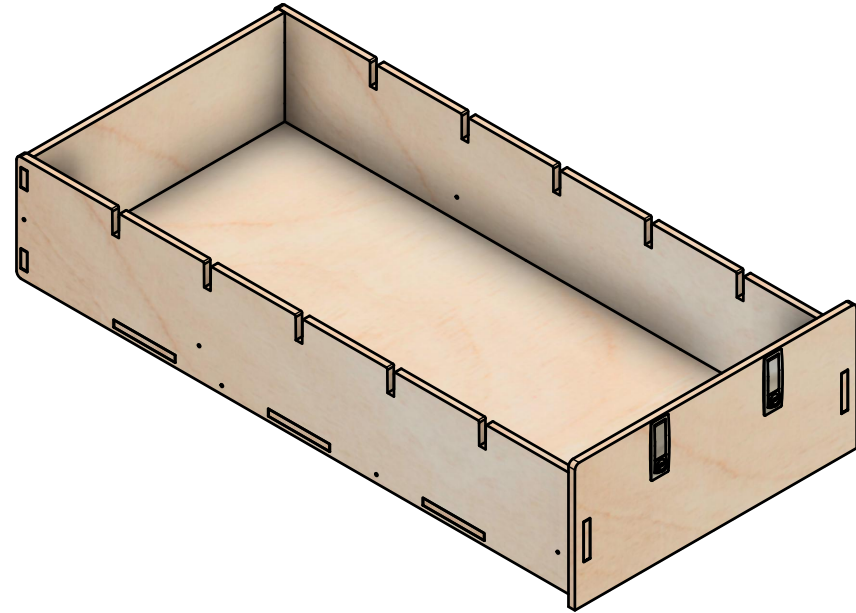

## Page 4 - Bay B Drawer Dimensions

All units in mm  
Plywood thickness = 12mm

# False Floor No.3B

SKU: BP\_18\_L1\_FF3B

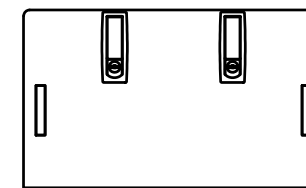
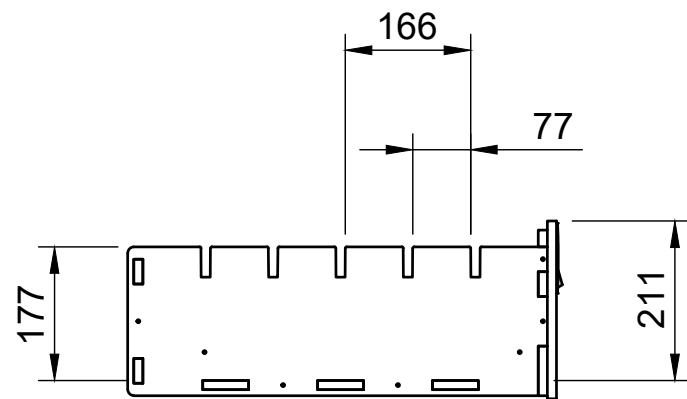
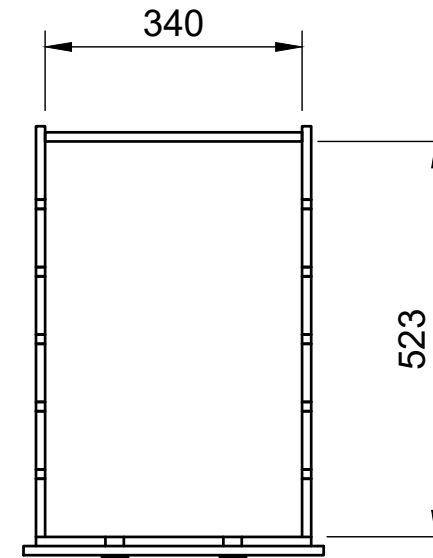
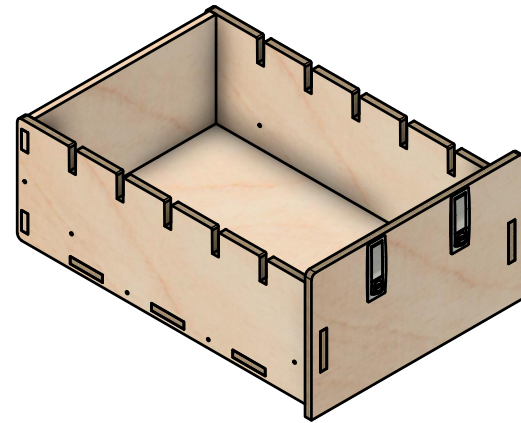

## Page 5 - Bay C Half Length Drawer Dimensions

All units in mm  
Plywood thickness = 12mm

**YOKE VANS**  
info@yoke-van-kits.co.uk  
0208 132 9221

© 2023 Yoke CNC LTD

# False Floor No.3B

SKU: BP\_18\_L1\_FF3B

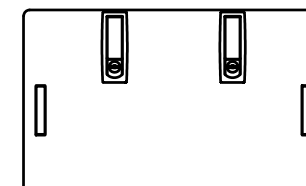
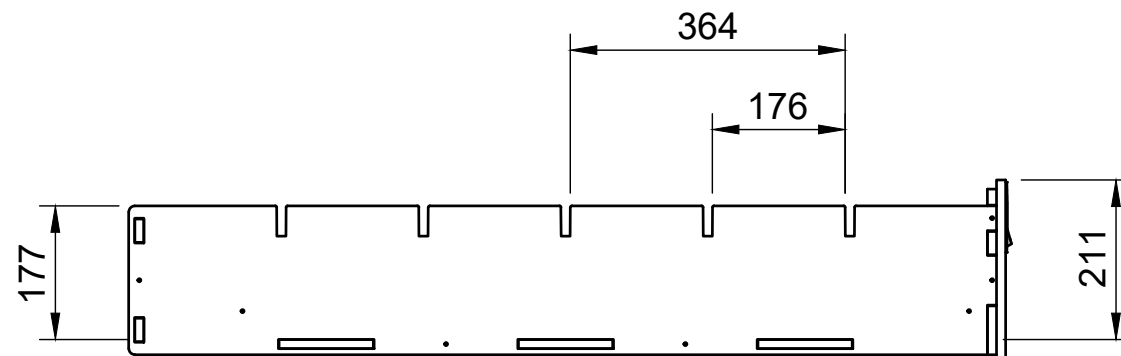
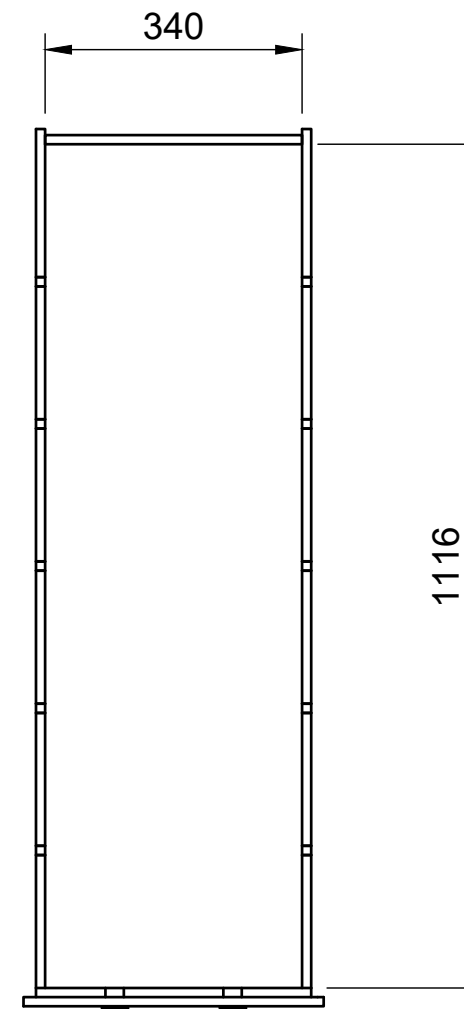
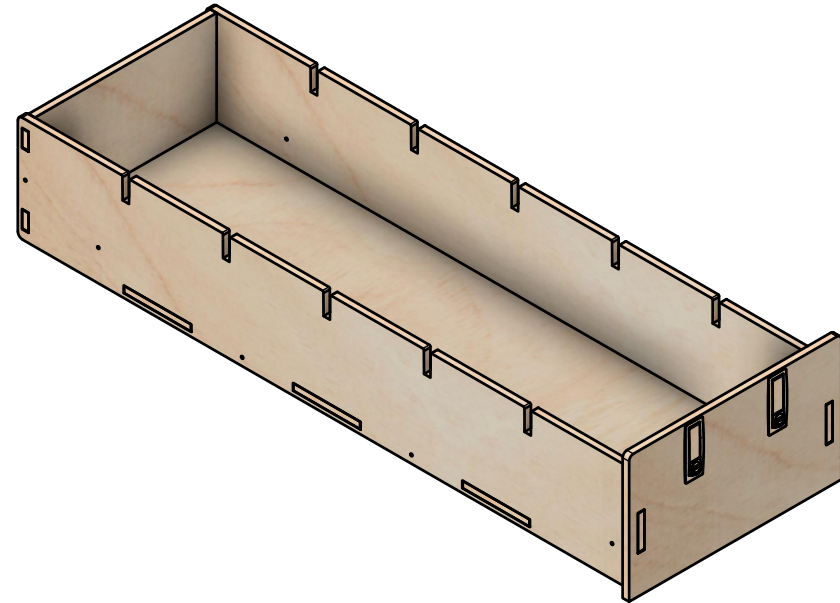

## Page 6 - Bay C Half Length Drawer Dimensions

All units in mm  
Plywood thickness = 12mm